

INSTALLATIE VOORSCHRIFT

DOUCHEDEUR IN NIS met NANO behandeld glas

1600x2000mm
(1600-1620) x2000mm

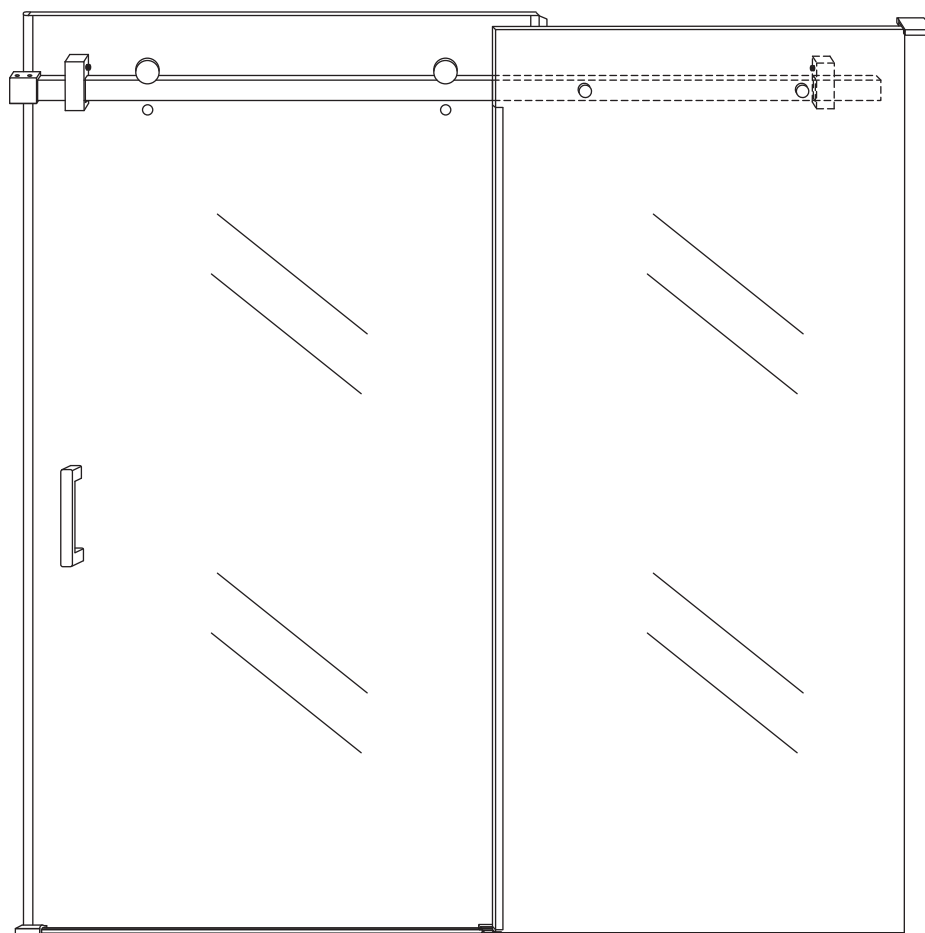



Zonder NANO

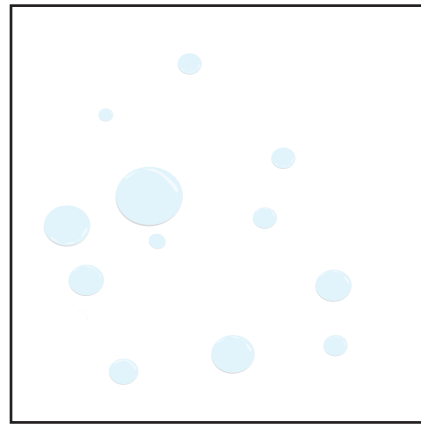

NANO



beide zijden NANO behandeld



beide zijden NANO behandeld

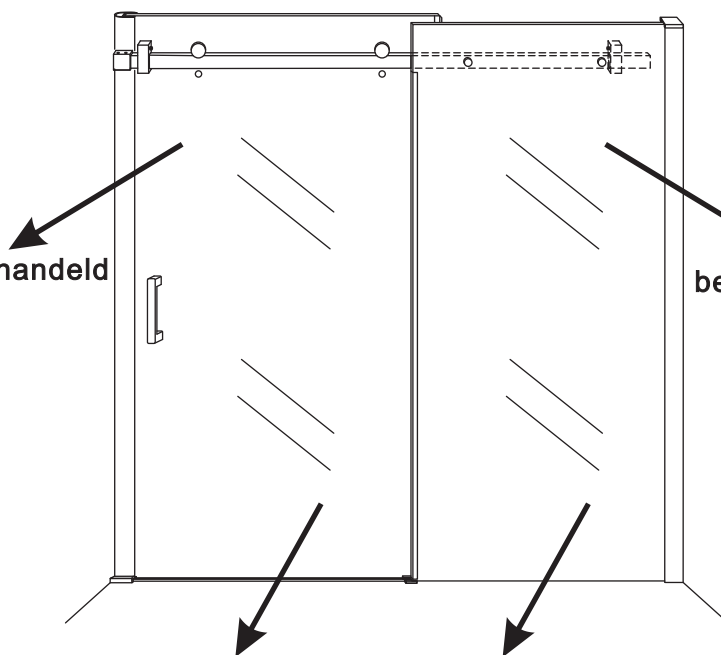

beide zijden NANO behandeld

NANO garantie: 2 jaar bij normaal gebruik

LET OP: gebruik geen grove scherpe voorwerpen, zoals schuursponsjes of staalwol om het glas schoon te maken.

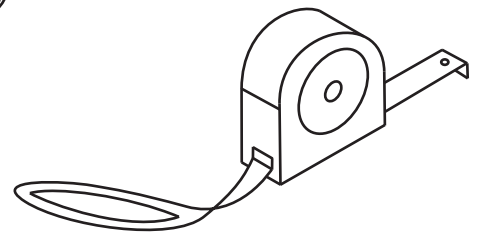
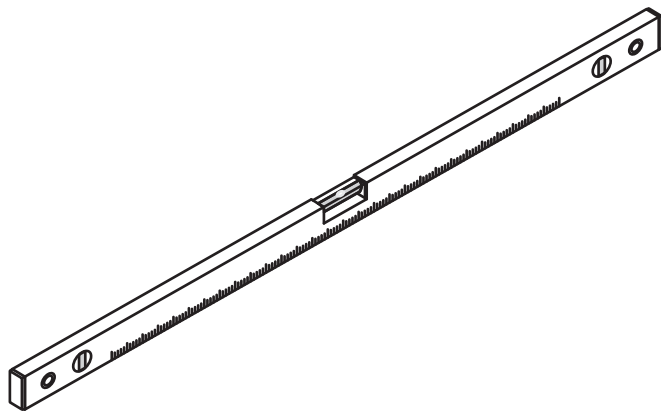

1



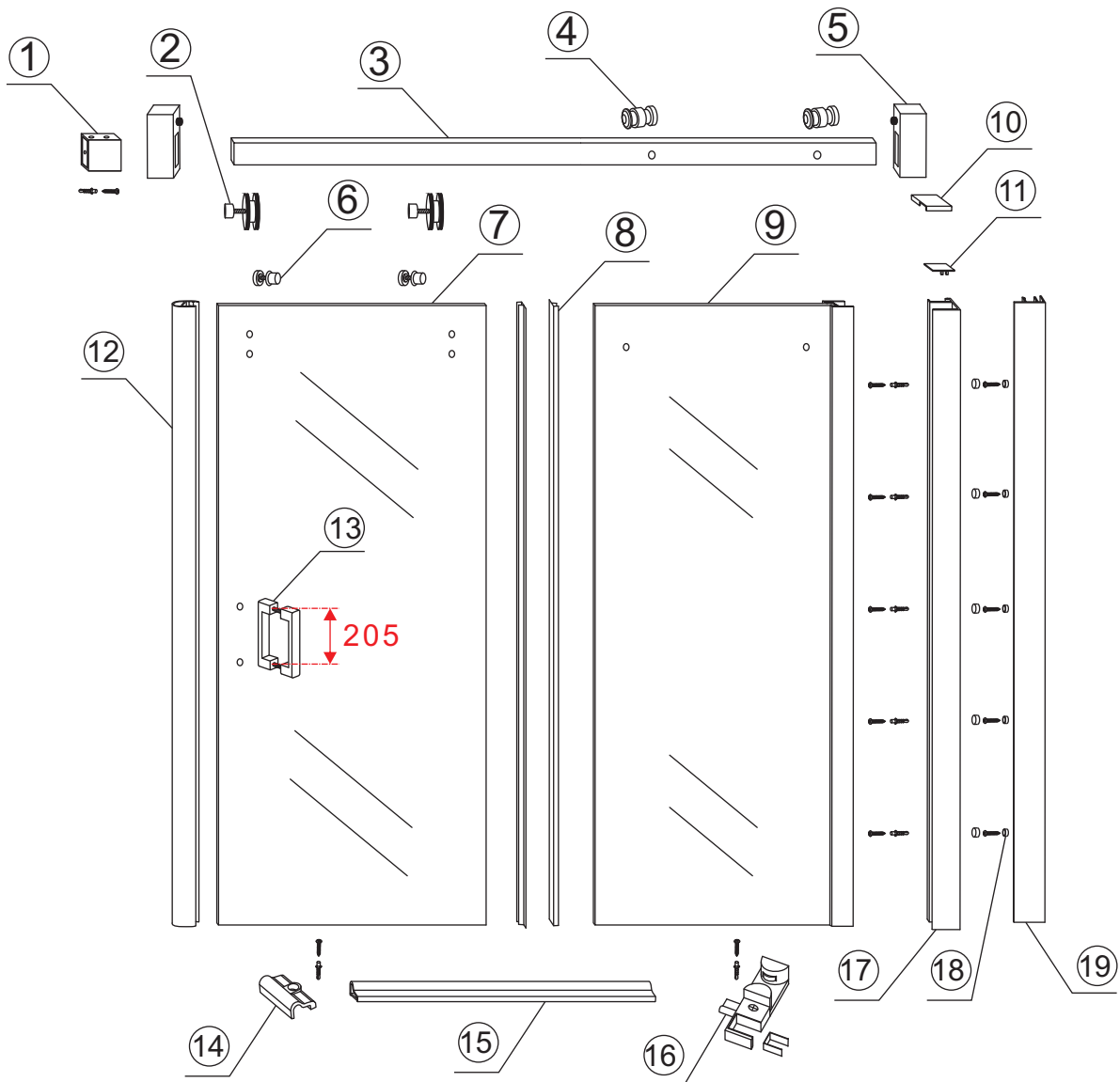

- | | | | | | | |
|------|------|------|------|------|------|------|
| ① X1 | ② X2 | ③ X1 | ④ X2 | ⑤ X2 | ⑥ X2 | ⑦ X1 |
| ⑧ X2 | ⑨ X1 | ⑩ X1 | ⑪ X1 | ⑫ X1 | ⑬ X1 | ⑭ X1 |
| ⑮ X1 | ⑯ X1 | ⑰ X1 | ⑱ X5 | ⑲ X1 | X13 | X8 |

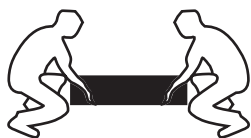

3

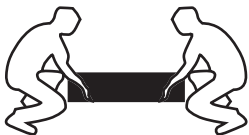
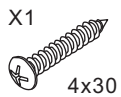
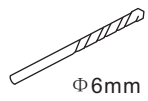
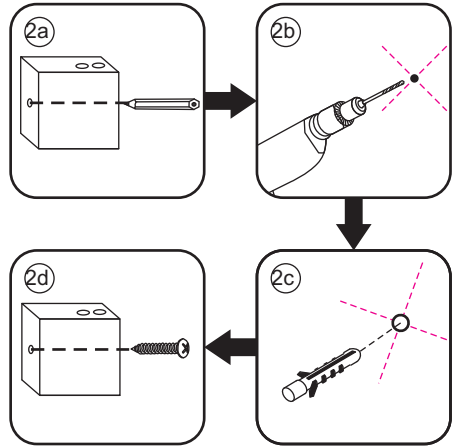
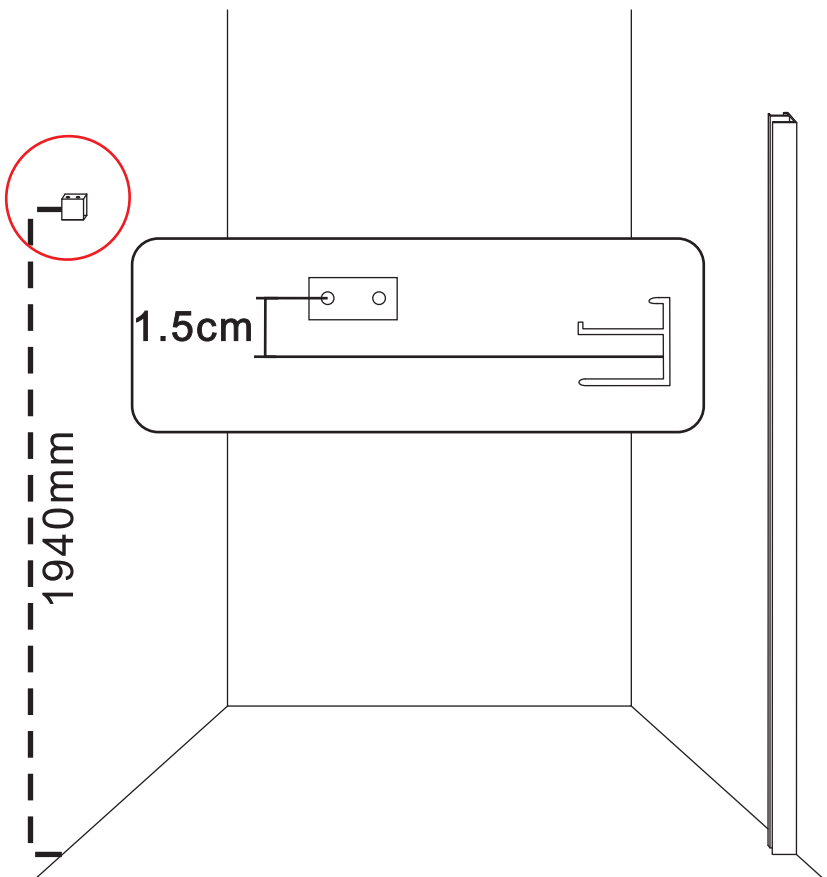
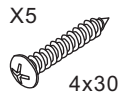
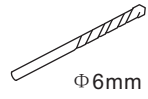
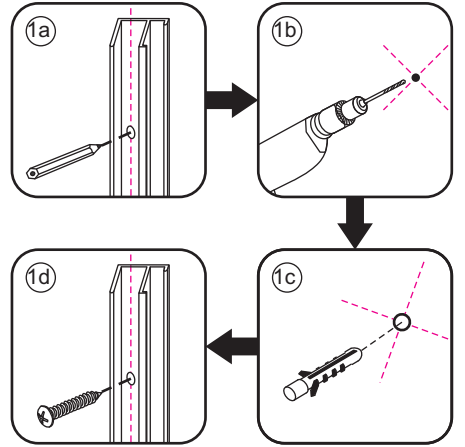
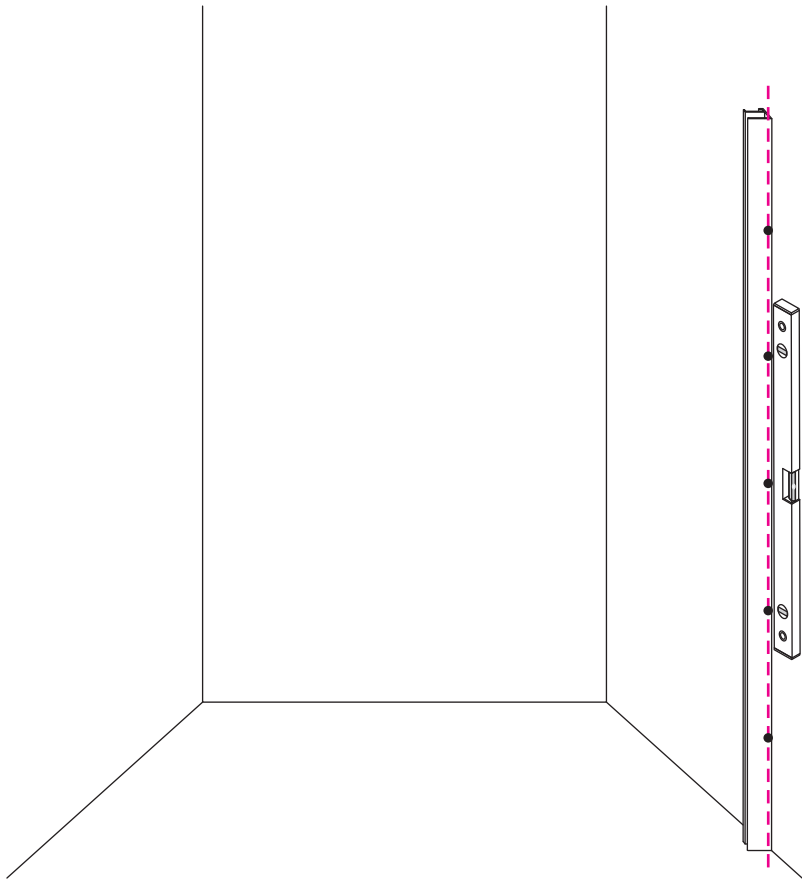

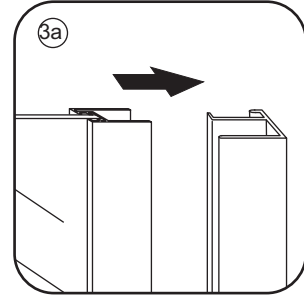
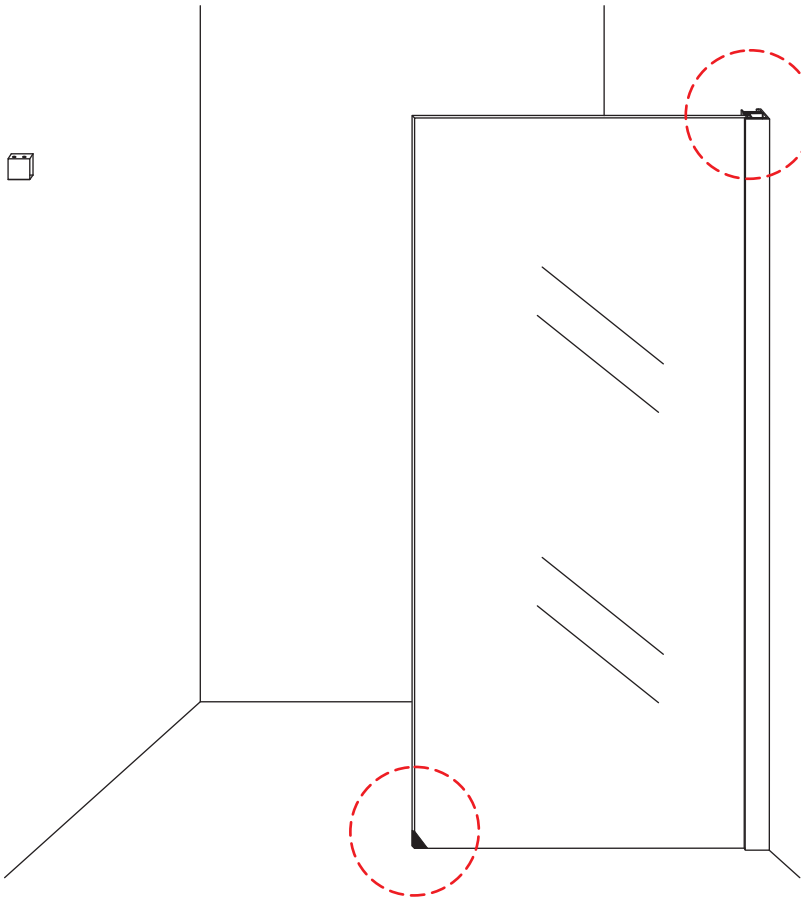

 **Verwijder de zwarte hoekbeschermers pas als de cabine helemaal is geïnstalleerd!**

4

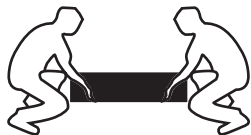
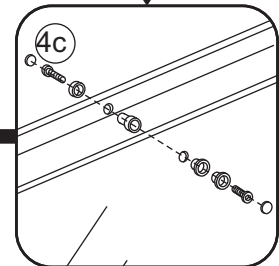
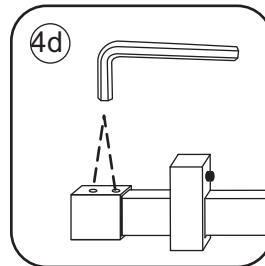
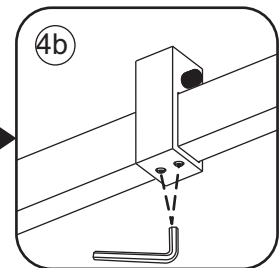
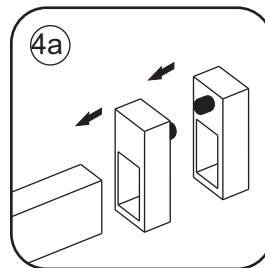
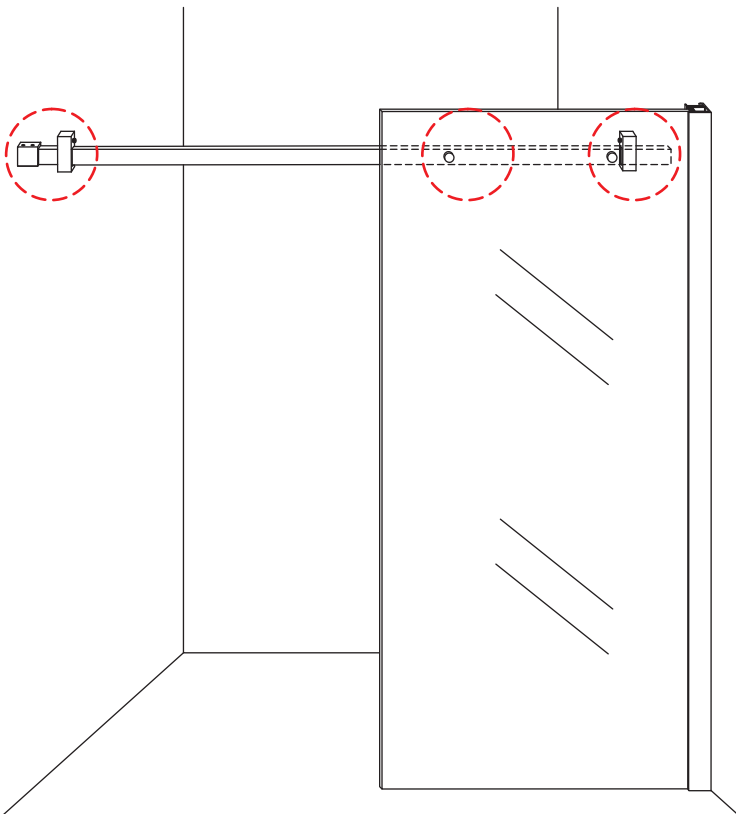

5

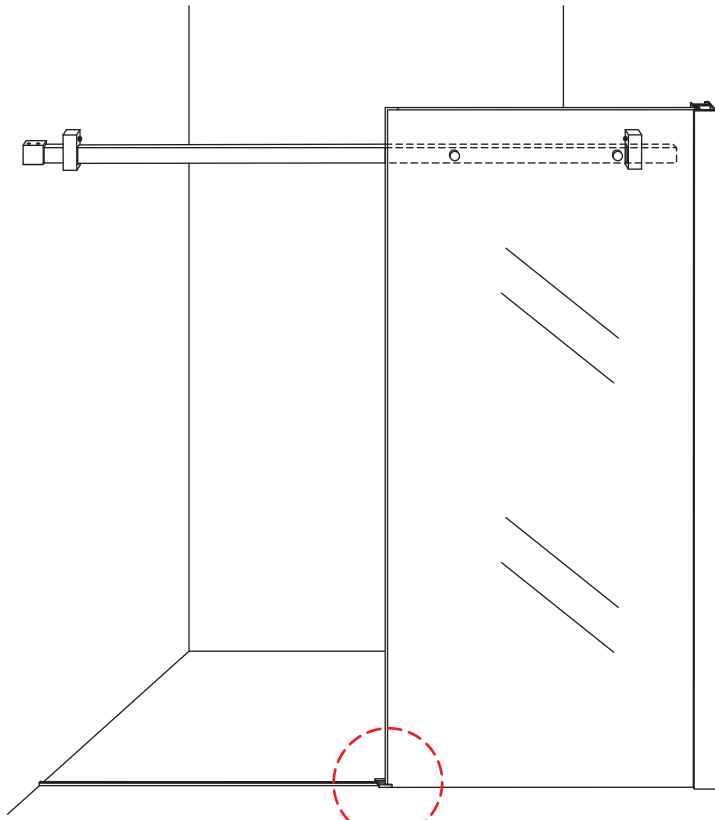

5a: Marking the top edge of the cabinet frame with a pencil.

5b: Drilling a hole in the top edge of the cabinet frame.

5c: Drilling a hole in the side edge of the cabinet frame.

5d: Inserting a screw into the hole in the top edge.

5e: Inserting a screw into the hole in the side edge.

5f: Tightening the screws with a screwdriver.

Φ6mm X1
4x25 X1
Φ6x30 X1

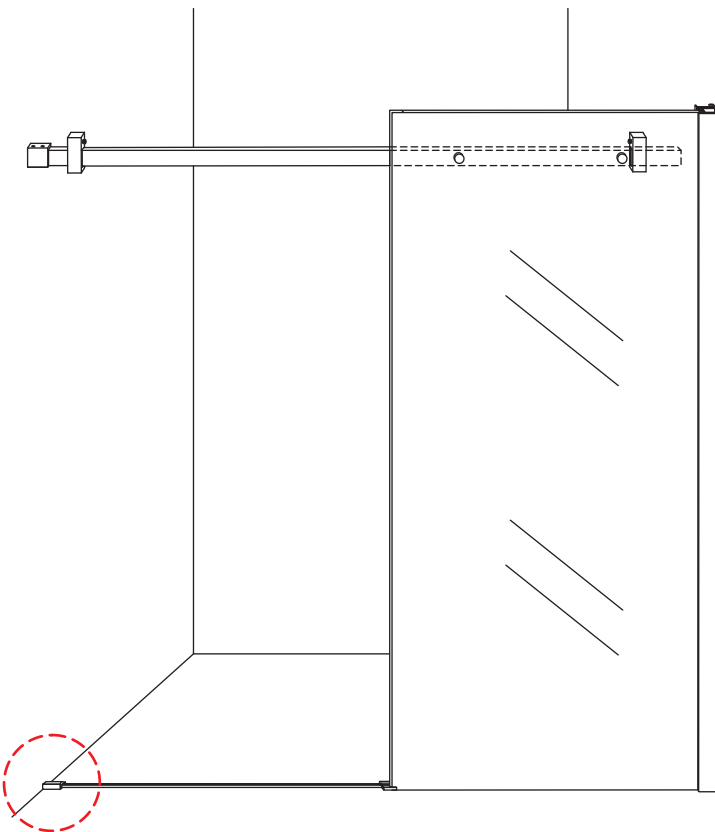

6a: Marking the top edge of the cabinet frame with a pencil.

6b: Drilling a hole in the top edge of the cabinet frame.

6c: Drilling a hole in the side edge of the cabinet frame.

6d: Inserting a screw into the hole in the top edge.

6e: Inserting a screw into the hole in the side edge.

Φ6mm X1
4x25 X1
Φ6x30 X1

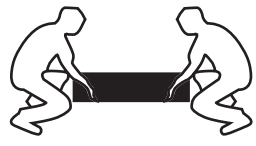

Φ6mm X1
4x25 X1
Φ6x30 X1

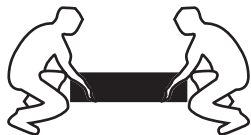
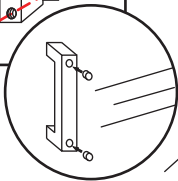
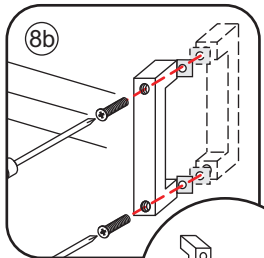
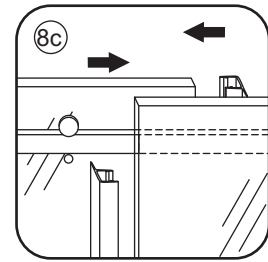
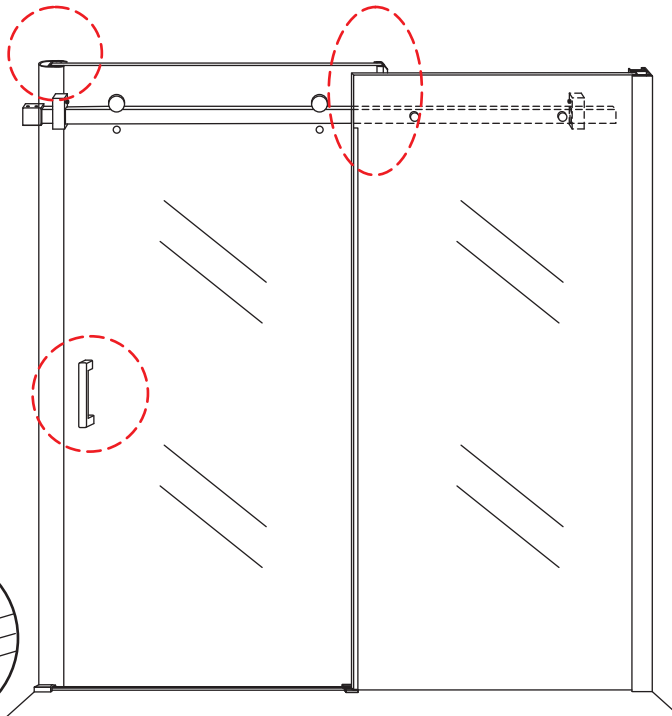
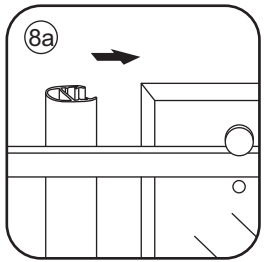
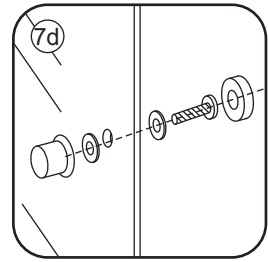
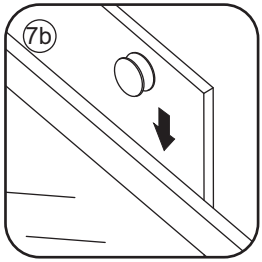
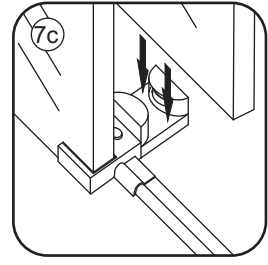
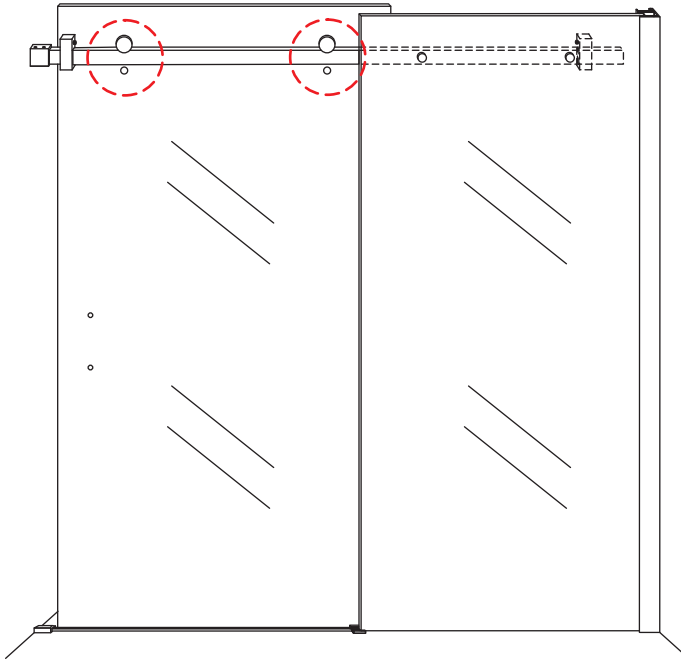
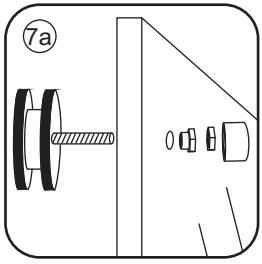

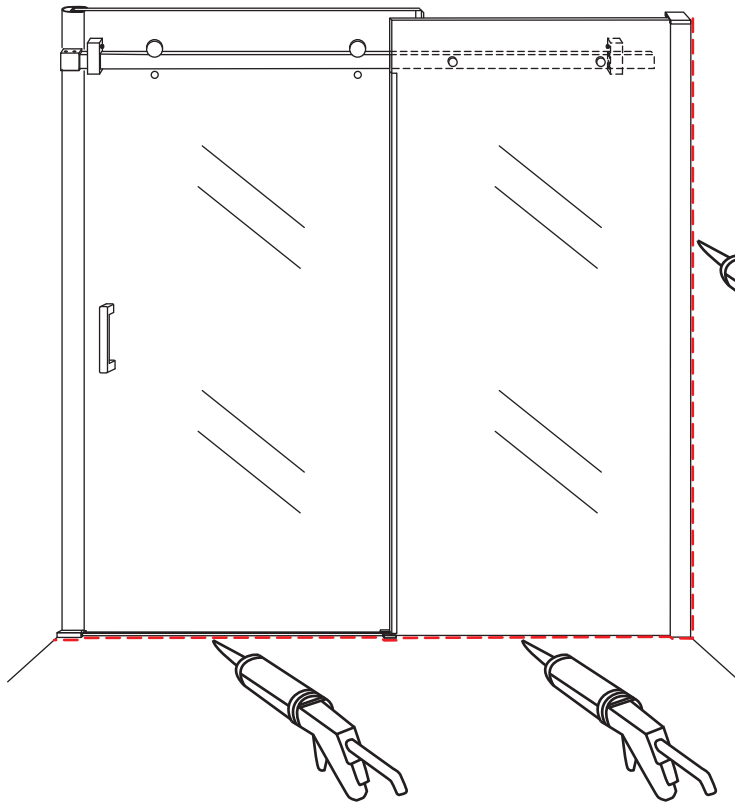
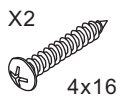
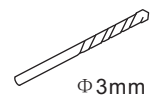
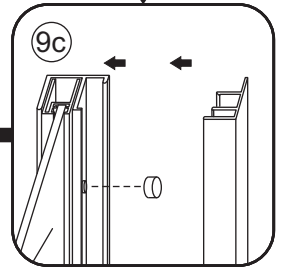
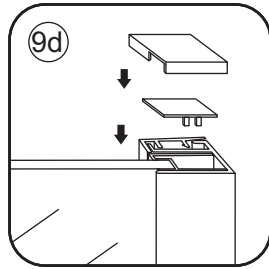
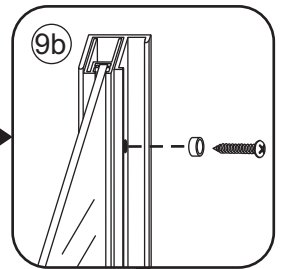
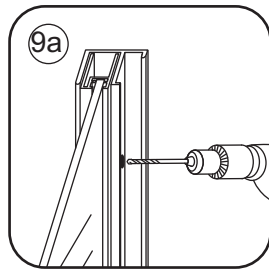
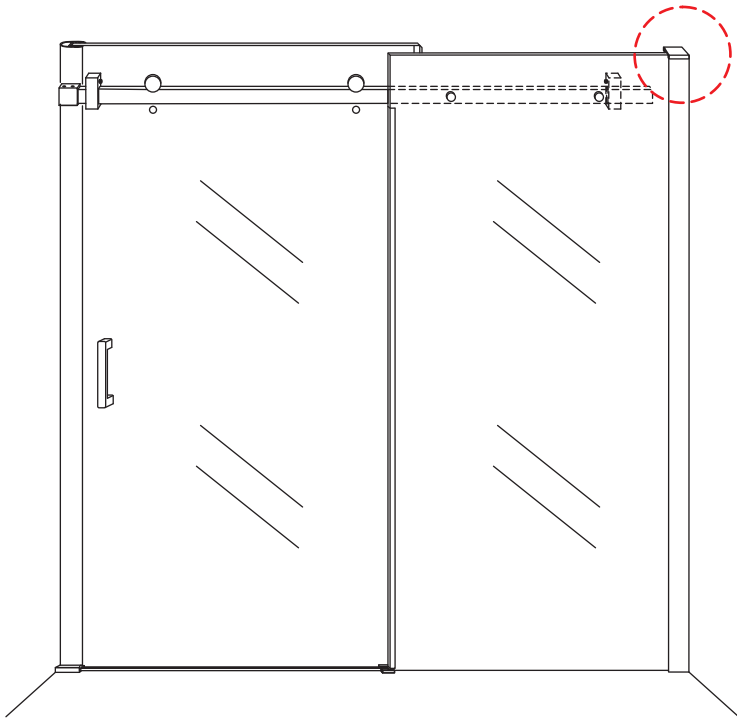

**Voorzie alleen de
buitenzijde van de
cabine van siliconenkit.**

